

EXTERIOR DOT-HP PRO

OUTDOOR-RATED, HIGH-OUTPUT RGBW LED CONNECTOR-BASED DOT

SPEC SHEET



OVERVIEW

The Martin **Exterior Dot-HP Pro** is a bright, outdoor-rated RGBW Dot, designed to create media facades or perimeter lighting on large buildings and structures for long-distance viewing. Each **Exterior Dot-HP Pro** is color- and brightness-calibrated for superior visual consistency across the entire installation. **Exterior Dot-HP Pro** is controllable via Martin P3 System Controllers or any SACN or Art-Net-based controller.

It is the perfect solution for integrating LED video technology into facades, landmarks, architectural elements or any other structure, indoors or out. The **Exterior Dot-HP Pro** comes with hybrid In/Out connectors for easy and versatile installations options.

Mapping video onto **Exterior Dot-HP Pro** is quick and intuitive via the P3 System Controller, eliminating the need for complex setups and time-consuming addressing. Each **Exterior Dot-HP Pro** includes 16 RGBW LEDs with a total luminous intensity of 90 candela.

Unifying unparalleled performance, adaptability, and intuitive operation, the Exterior Dot Pro family doesn't just enable lighting designers and professionals to surpass the limitations of traditional systems, it inspires them to redefine the boundaries of creative video design..

KEY MESSAGES

HIGHER OUTPUT

Exterior Dot Pro models deliver premium brightness and extraordinary light quality, based on highly efficient RGBW LEDs.

EFFICIENT COLOR BOOST

Exterior Dot Pro color boost technology is extremely efficient, resulting in higher lumen output on saturated and mixed colors than traditional systems.

SMART DESIGN KIT

The Exterior Dot Pro solution includes a variety of smart accessories to empower lighting designers with a smart design kit of creative options to support a wide array of applications.

MULTIPLE CONTROL OPTIONS

Exterior Dot Pro simplifies control by integrating industry standard Art-Net and sACN control protocols, or Martin's award-winning P3 control protocol. A smart, stand-alone mode via Martin Companion is also included.

SIMPLE YET ROBUST INFRASTRUCTURE

Exterior Dot Pro utilizes a simple, yet robust flexible infrastructure to deliver more cost-effective system solutions and easier installs, allowing for longer daisy-chains and high fixture runs.

DESIGNED FOR PERMANENT, OUTDOOR USE

The Exterior Dot Pro family meet rigorous environmental standards and are backed by a 5-year warranty. This family is designed for permanent indoor and outdoor installations.

EXTERIOR DOT-HP PRO

OUTDOOR-RATED, HIGH-OUTPUT RGBW LED CONNECTOR-BASED DOT

SPEC SHEET

PRODUCT FEATURES

- Powerful, connector-based, direct-view LED lighting
- Powered directly from Martin P3 PowerPort or third-party 48 VDC PSU
- Large footprint of 78 mm diameter with clear front or diffused dome.
- Perfect for facade or stage integration
- Fully-weatherized housing (IP67, IK08 and C-5 High corrosion rating)
- Martin P3/Art-Net/sACN compatible (automatic protocol detection)
- Setup and Addressing via RDM over Art-Net or Martin P3
- Real-time status feedback via RDM over Art-Net and Martin P3
- Individually-controllable RGBW Dots
- Color boost for bright, saturated, and mixed colors
- Dedicated color temperature control channel
- In-built Effect Macros (FX) for easy creation of stunning looks
- Up to 68 Exterior Dot-HP Pro units can be daisy-chained
- Reduced power mode for longer cable runs and fixture counts
- Combined power/data input over single cable (hot-pluggable)
- Superior color and brightness consistency based on factory calibration
- Stand-alone programming with up to 20 scenes
- Intuitive mapping and addressing via P3 System Controller family
- Shipped in FSC-certified cardboard packaging
- 5-year warranty

RELATED ITEMS

- P3-175 System Controller:P/N MAR-90721100
- P3-275 System Controller:P/N MAR-90721101
- P3-PC System Controller: Free download from www.martin.com
- Martin Companion: Free download from www.martin.com



ACCESSORIES

POWER AND DATA SUPPLY UNITS

- P3 PowerPort 2000:P/N MAR-90721200
- P3 PowerPort 500 IP Rental:P/N MAR-90721201
- P3 PowerPort 500 IP Install:P/N MAR-90721202
- DCE PSU 240 IP:P/N MAR-90721203

DATA SPLITTER & BOOSTER FOR SPLIT OR EXTENDED CABLE RUNS

- DCE DataSplitterBooster IP:P/N MAR-90721204

PRE-ASSEMBLED HYBRID DCE CABLES

- DC + Ethernet Cable DCE-DCE 1m:P/N MAR-91700100
- DC + Ethernet Cable DCE-DCE 2.5m:P/N MAR-91700101
- DC + Ethernet Cable DCE-DCE 5m:P/N MAR-91700102
- DC + Ethernet Cable DCE-DCE 10m:P/N MAR-91700103
- DC + Ethernet Cable DCE-DCE 25m:P/N MAR-91700104

BULK HYBRID DCE CABLES

- DC + Ethernet Cable 100m:P/N MAR-91700105
- DC + Ethernet Cable LSZH 100m:P/N MAR-91700106

FIELD-INSTALLABLE DCE CONNECTORS

- Field-installable Connector DCE Male:P/N MAR-91700107
- Field-installable Connector DCE Female:P/N MAR-91700108

CLOSING CAPS FOR DCE CONNECTORS

- Closing Cap Male DCE Connector:P/N MAR-91700109
- Closing Cap Female DCE Connector:P/N MAR-91700110

HYBRID DCE ADAPTERS

- DC + Ethernet Adapter DCE Male-Male:P/N MAR-91700111
- DC + Ethernet Adapter DCE Female-Female:P/N MAR-91700112
- DC + Ethernet Adapter EtherCON+Wires to DCE:P/N MAR-91700113
- DC + Ethernet Adapter DCE to EtherCON:P/N MAR-91700114

INSTALLATION ACCESSORIES

- Dot-HP Pro Flange Bracket, 10 pcs:P/N MAR-90581012
- Mounting Profile Kit, Dot-HP Pro:P/N 91606021

TOOLS

- Exterior Multitool :P/N MAR-90590025

ORDERING INFORMATION

- Exterior Dot-HP Pro clear front, grey in cardboard box: P/N MAR-90581000
- Exterior Dot-HP Pro diffused dome, grey in cardboard box: P/N MAR-90581010

EXTERIOR DOT-HP PRO

OUTDOOR-RATED, HIGH-OUTPUT RGBW LED CONNECTOR-BASED DOT

SPEC SHEET

TECHNICAL SPECIFICATIONS

CONTROL AND PROGRAMMING

Control protocols	Martin P3, Art-Net or sACN
Protocol detection	Automatic
RDM compliance	ANSI/ESTA E1.20
Art-Net Compliance	Art-Net 1, 2, 3 and 4; including RDM over Art-Net
sACN Compliance	ANSI E1.31 – 2016
Martin P3 Compliance	P3 System Controller Software 6.1.0 or newer
Ethernet Transceiver	10/100Mbit
Control resolution	16-bit (P3) or 8-bit (DMX) control of each color
DMX Modes	Standard, Extended, Raw, RGB or PixelMap
DMX Channels	6, 12, 4, 3, 48
Fixture identification	User-settable ID number
User interface	Magnetic sensor for local diagnostics and testing
Setting and addressing	Martin P3 System controller or RDM (over Art-Net)-compliant controller
Firmware update	Via Ethernet using Martin Companion / P3 System Controller

OPTICS

Light source	16 x RGBW LEDs
Minimum LED lifetime	100,000 hours (to >70% luminous output)*
LED manufacturer	LumiLeds
Binning	Tight color and flux binning
Calibration	Full Gamut Color Calibration

*Figure obtained under manufacturer's test conditions at Ta 25°C

PHOTOMETRIC DATA

Color resolution	16 bits per color (64 bit per pixel)
Dot pitch*	78 mm - 500 mm (fixture to fixture)
CRI (Color Rendering Index)	> 70
Color Temperature	2,000 – 12,000 K
Viewing angle Clear front	150°
Viewing angle Diffused dome	180°

LUMINOUS INTENSITY

	Clear front	Diffused dome
Full@6500K	90 cd	56 cd

PHOTOMETRIC DATA (Cont.)

LUMINOUS OUTPUT**

	Clear front	Diffused dome
Full@6500K:	260 lm	175 lm
Red:	80 lm	55 lm
Green:	230 lm	155 lm
Blue:	60 lm	40 lm

* Dot pitch can be extended using hybrid DCE cables.

** All Photometric Data measured in steady state (30 minutes warm-up time) at 25°C ambient

CONSTRUCTION

Color	Traffic Grey RAL 7042 (custom colors available on request)
Base	Cast aluminum
Surface treatment	Anodized and electrostatic powder-coated
Effective Projected Area (EPA)	0.007 m ²
Protection rating	IP67
Impact resistance	IK08
Corrosion resistance	C5 High (ISO 12944-6)
Vibration resistance	1.0g, Sinusoidal (IEC 60068-2-6), 0,7g RMS Random (IEC 60068-2-64), 3.0g (ANSI C136-31)

INSTALLATION

Mounting points	Direct surface mount or accessory mounting plate
Orientation	Any

CONNECTIONS

Input	DCE connector cable tail for Power & data input, IP67
Output	DCE connector cable tail for Power & data thru, IP67
Connection	Hot-pluggable
Max. daisy-chain (Full Power mode)	68 fixtures including 50 m cable
Max. daisy-chain (Reduced Power mode)	125 fixtures including 50 m cable.

* Refer to system diagram for details on fixture run limitations.

ELECTRICAL

Nominal input voltage	48 VDC +/- 4%
Power supply options	Martin P3 PowerPort 2000, P3 PowerPort 500 IP Install, P3 PowerPort 500 IP Rental, Martin DCE PSU 240 IP or generic 48 VDC PSU
Surge protection	4 KV

EXTERIOR DOT-HP PRO

OUTDOOR-RATED, HIGH-OUTPUT RGBW LED CONNECTOR-BASED DOT

SPEC SHEET

DIMENSIONS

ELECTRICAL (Cont.)

POWER CONSUMPTION

Maximum 5.7 W in full power mode
 Maximum 3.2 W in reduced power mode
 Idle 1.8 W
 Hibernation 1.5 W

* Measurements made at nominal voltage. Allow for a deviation of +/- 10%.
 Idle: all LEDs at zero intensity. Maximum at full intensity, full white. Idle at zero intensity. Hibernation: zero intensity, wake-up procedure to re-use fixture.

THERMAL

Cooling Convection

Total heat dissipation
 (calculated, +/- 10%) 17 BTU/hr.

Max ambient temperature (Ta max.) 55° C (131° F)*

Min ambient temperature (Ta min.) -30° C (-22° F)

*Above 45° C, the fixture starts regulating output to protect from overheating.

ENVIRONMENTAL

RoHS Compliant
 REACH Compliant
 WEEE Compliant
 Proposition 65 Compliant
 Packaging FSC certified cardboard inlay and outer box

Efficacy (max output) 50 lm/W
 LWR* 630 lm/kg (290 lm/lb)*

*LWR = Lumen-to-Weight Ratio

APPROVALS

Global CB Certification/IECEE IEC 62368-1
 EU safety EN 62368-1, EMC: EN55035 EN 55032, EN 61000-3-2, EN 61000-3-3
 US safety UL 62368-1, EMC: FCC Part 15 Class B
 Canadian safety CSA C22.2 No.62368-1, EMC: ICES-003 Class B
 Australia/NZ RCM - Pending
 United Kingdom UKCA
 India BIS IS 10322(Part5/section7) - Pending



DIMENSIONS

PHYSICAL

Diameter 78 mm (3.1 in.)
 Height with clear front 43 mm (1.7 in.)
 Height with dome front 58 mm (2.3 in.)
 Weight 395 g (0.86 lbs.)

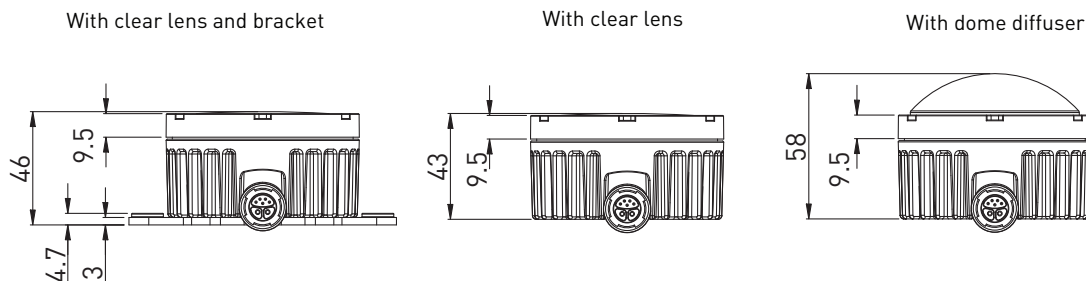

All dimensions are in mm

EXTERIOR DOT-HP PRO

OUTDOOR-RATED, HIGH-OUTPUT RGBW LED CONNECTOR-BASED DOT

SPEC SHEET

DIMENSIONS

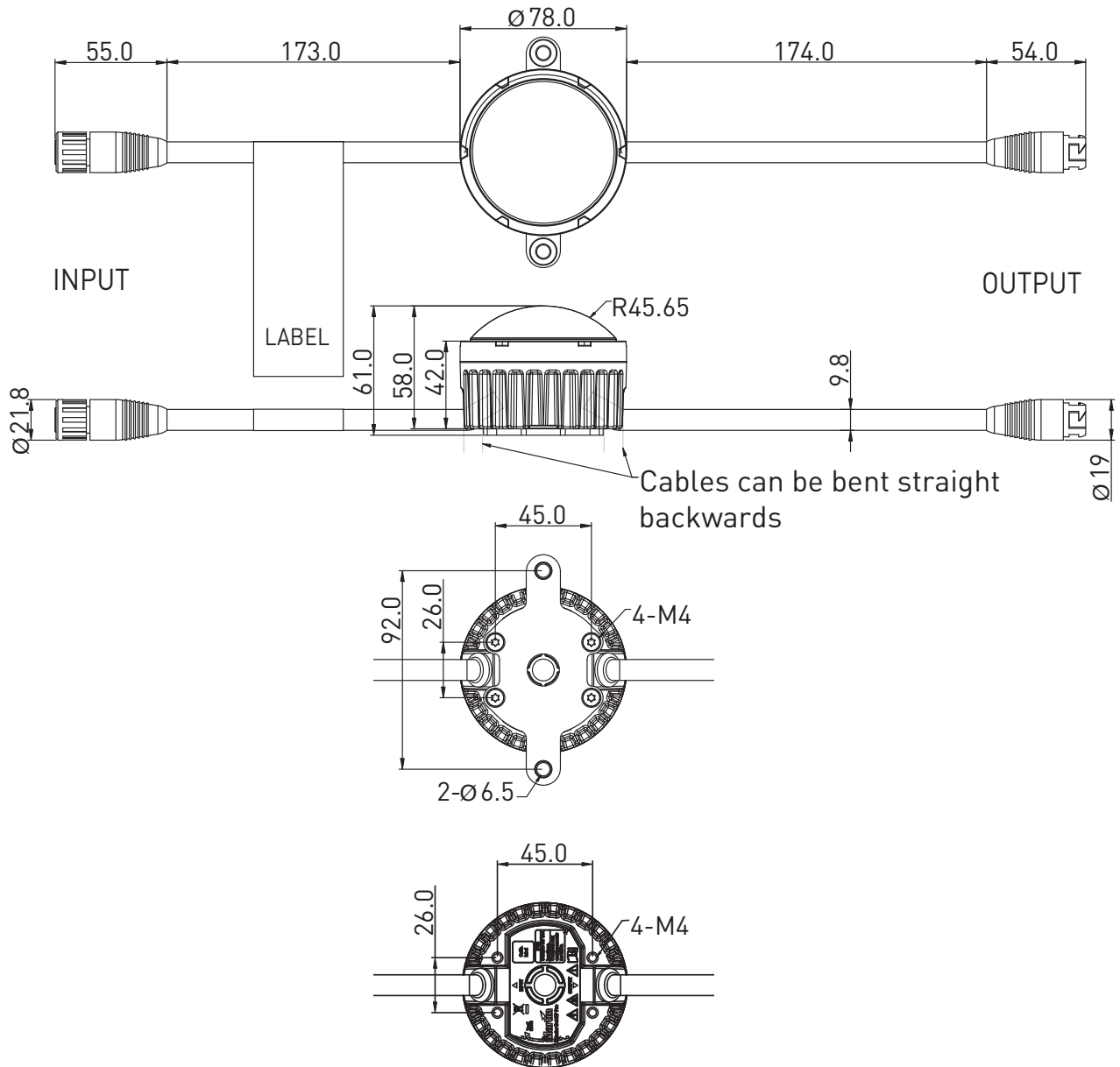

All dimensions are in mm

EXTERIOR DOT-HP PRO

OUTDOOR-RATED, HIGH-OUTPUT RGBW LED CONNECTOR-BASED DOT

SPEC SHEET

MOUNTING OPTIONS

DIRECT MOUNTING

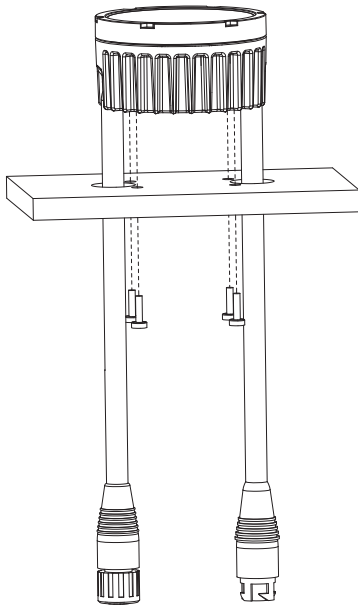

FLANGE BRACKET

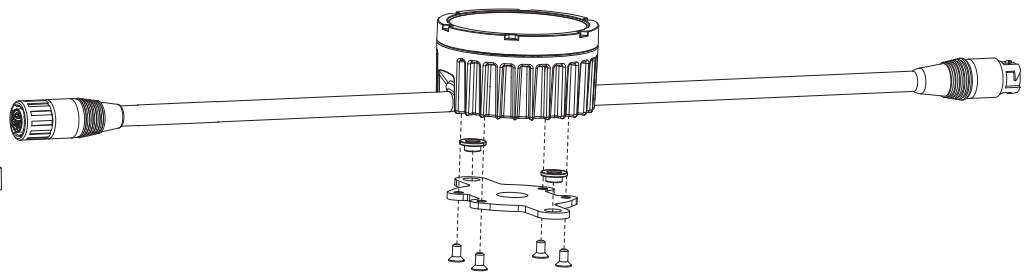

MOUNTING PROFILE

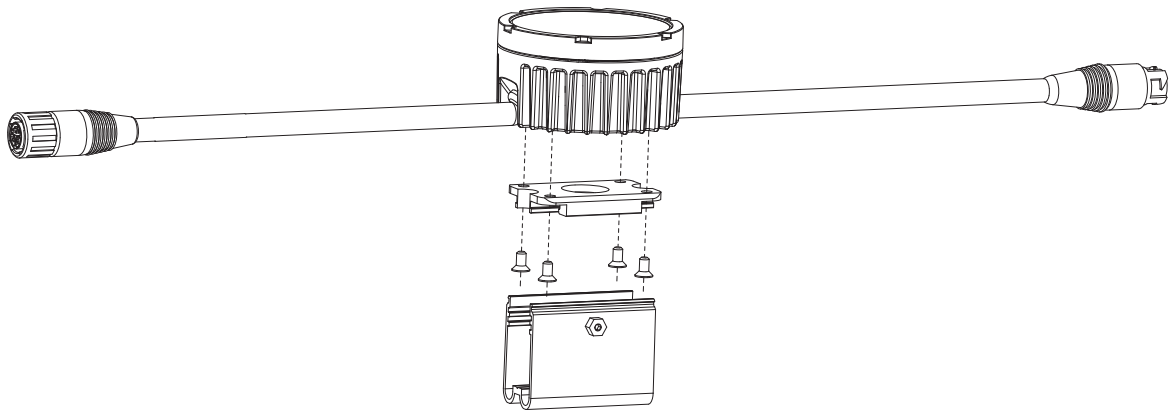

All dimensions are in mm