

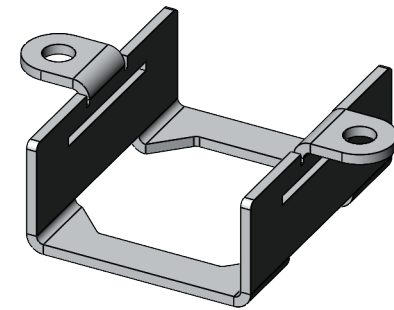

REVISION HISTORY

DATE	REV.	DESCRIPTION	BY
01.12.2020	B		LTousgaard

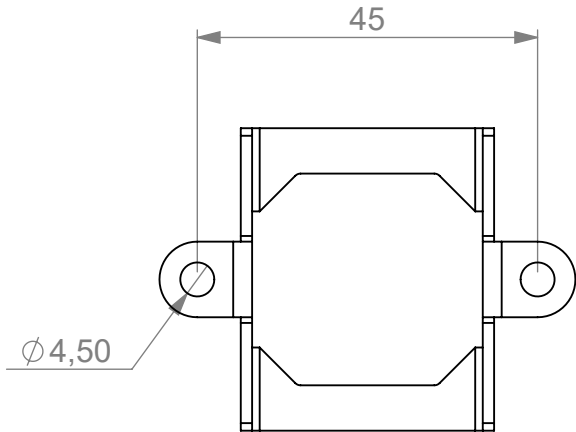
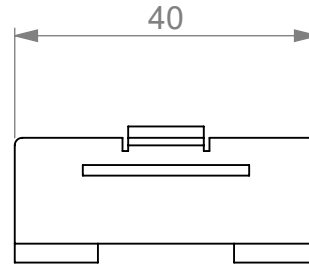
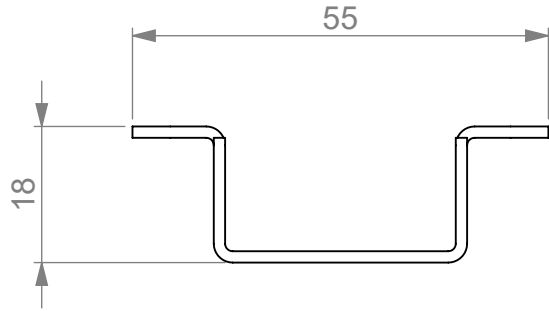

Weight: 7g (0,25 oz)

© 2020 HARMAN Professional Denmark ApS PROPRIETARY AND CONFIDENTIAL PROPERTY OF HARMAN. DO NOT DISCLOSE, REPRODUCE, OR PUBLISH WITHOUT WRITTEN HARMAN APPROVAL.	Material Aluminum EN AW-5754 H22	FIRST ANGLE PROJECTION 			HARMAN Professional Denmark ApS Olof Palmes Allé 44 DK 8200 Aarhus N	
	General linear tolerance		Surface treatment	TITLE (Model in view 91611302-B) Mounting Bracket, VC-Dot 4		
ROHS RESTRICTION OF HAZARDOUS SUBSTANCES ALL MATERIALS USED IN THIS PART MUST BE ROHS COMPLIANT. SUPPLIER SHALL PROVIDE A CERTIFICATE OF ROHS COMPLIANCE WITH THE FIRST ARTICLE.	General angular tolerance	Color	NO. _____ REV _____			
	General geometrical tolerance	Project number	SIZE A4	SCALE 1:1	UNIT mm	DO NOT SCALE DRAWING
DIMENSIONS SHOWN ARE FOR REFERENCE AND INSPECTION ONLY. REFER TO CAD MODEL PROVIDED WITH THIS DRAWING FOR OVERALL DEFINITION OF PART GEOMETRY.						